















name	tip.	stk.	bild
KO 01	8x35	8	
KN 03	7x50	8	
PL 12		4	
PP 01	d=5	4	
PN 01-PD 01		2	
AK 103		2	
SP 01	4x32	2	
DR 27	3,5x16	8	
DR 30	4,0x30	6	
KV 01	1,5x20	10	
PL 16	8x60	2	
HK 01	6x50	2	
UC 07	96	1	
KL 01	4	1	



Schritt 1.

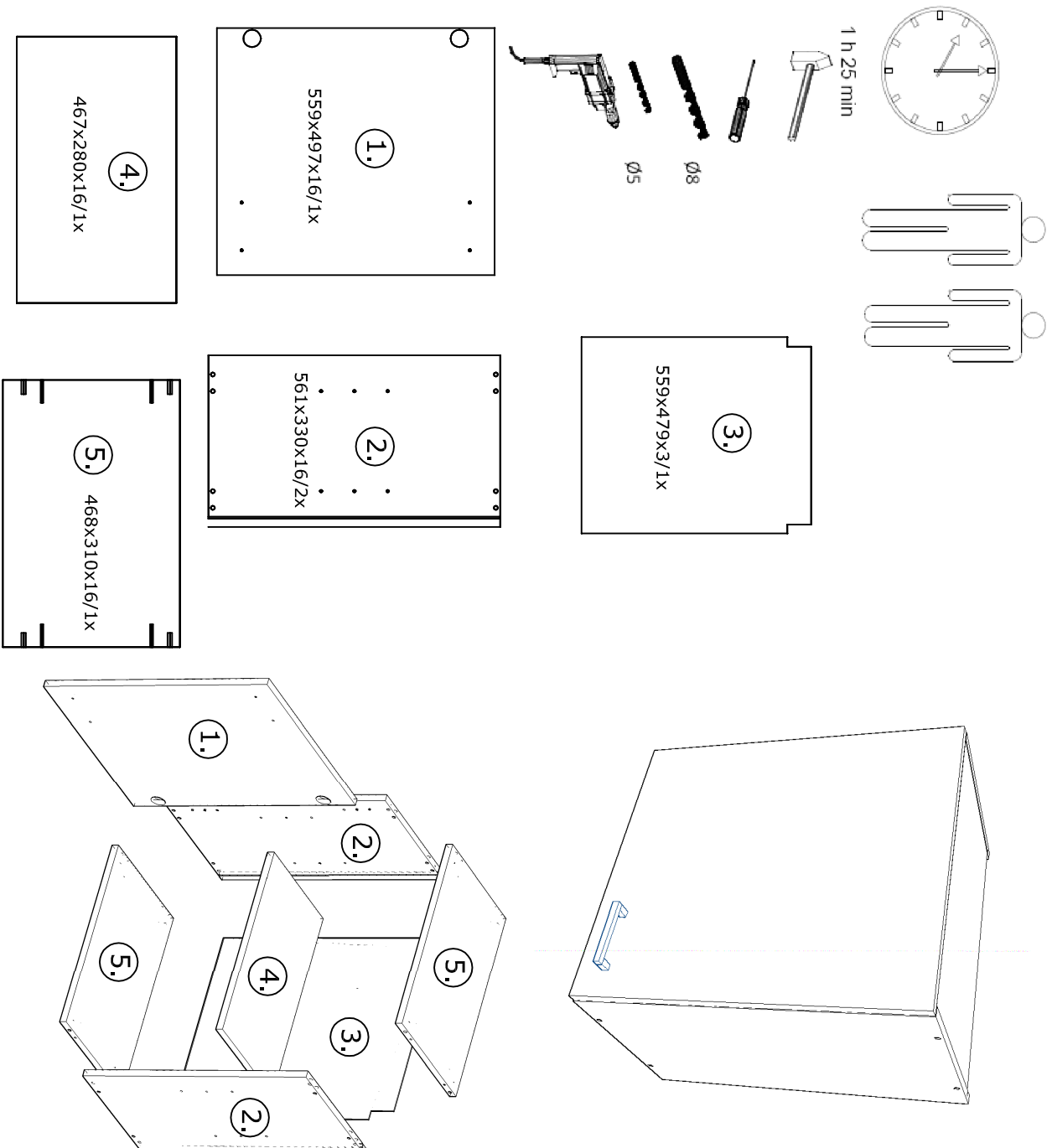
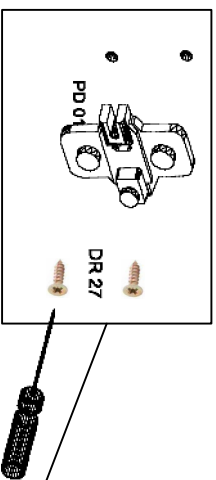

Schritt 2.

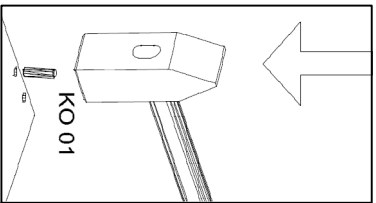

Schritt 3.

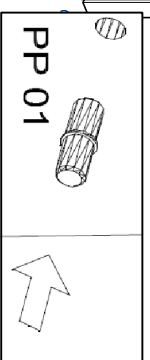

Schritt 5.

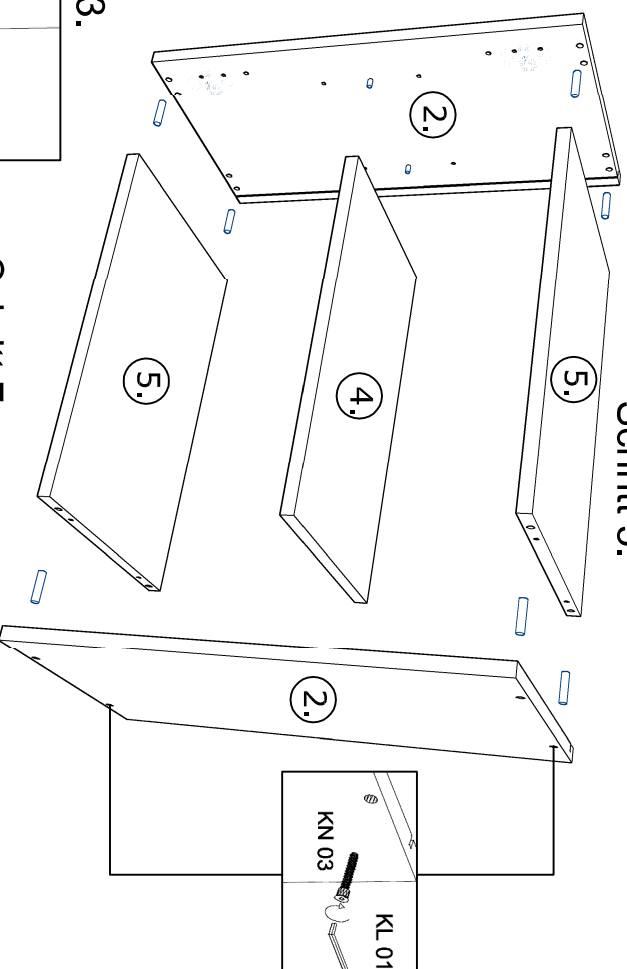

Schritt 7.

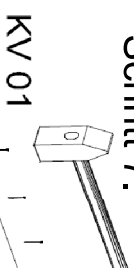

Schritt 4.

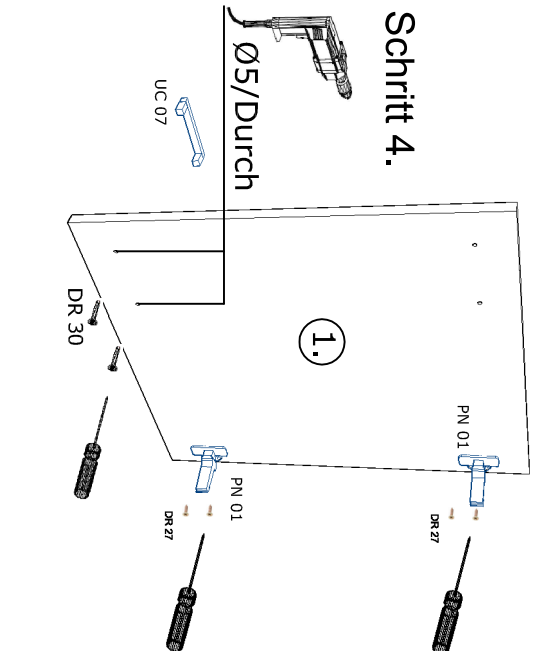

Schritt 6.

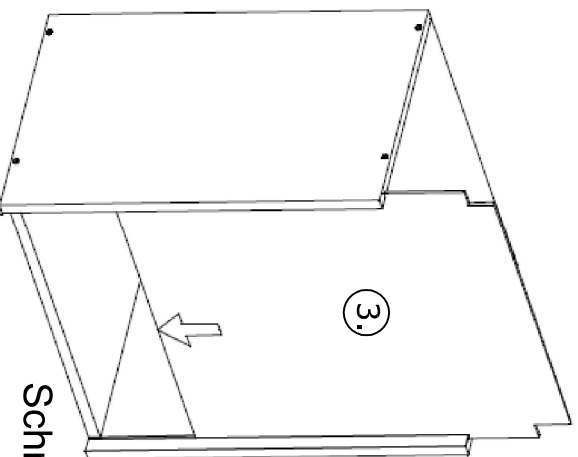

Schritt 8.

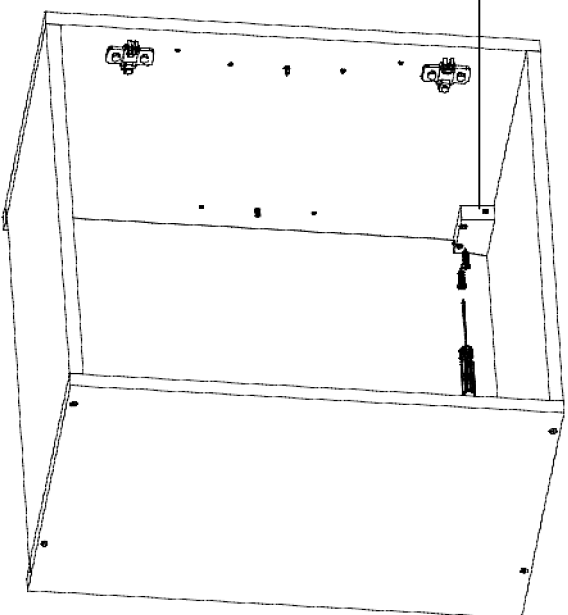
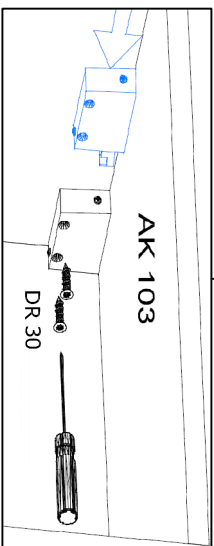

Schritt 9.

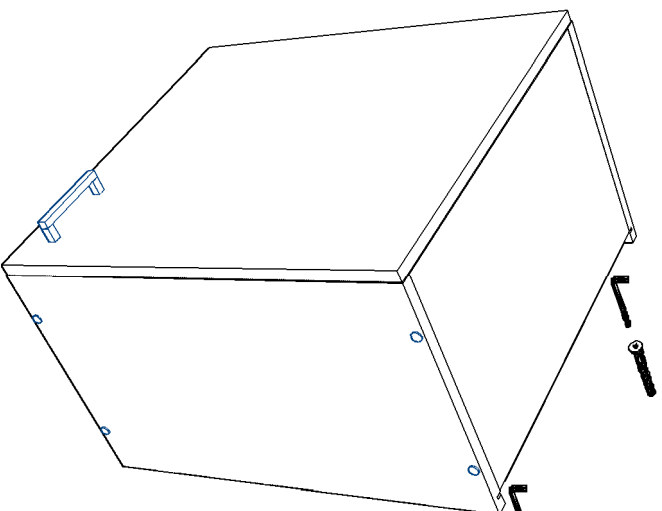
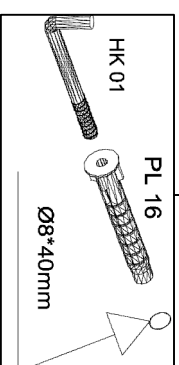

Schritt 10.

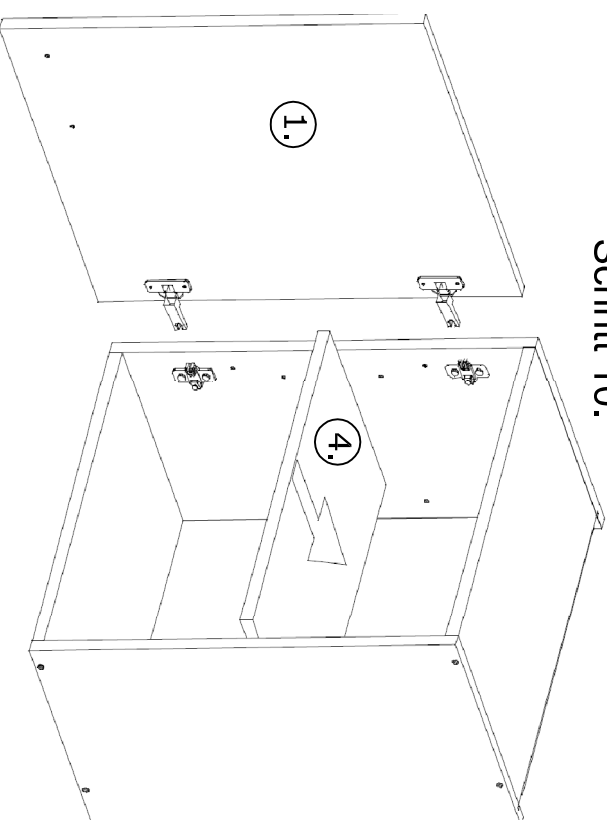

name	tip.	stk.	bild
KO 01	8x35	20	
KN 03	7x50	8	
PL 12		4	
PP 01	d=5	4	
PN 01-PD 01		2	
VG 02	450	2	
SP 01	4x32	2	
DR 27	3,5x16	21	
DR 30	4,0x30	2	
KV 01	1,5x20	15	
PL 01	15gr	1	
UC 07	96	2	
DR 25	4,0x25	6	
KL 01	4	1	
DR 45	4,0x45	2	
EU 01	6,3x14	6	
AK 145	30x30	4	

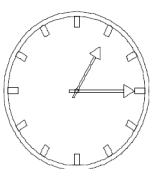

1 h 50 min

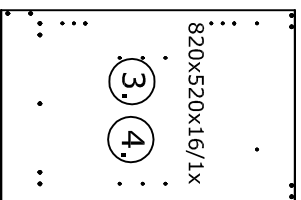
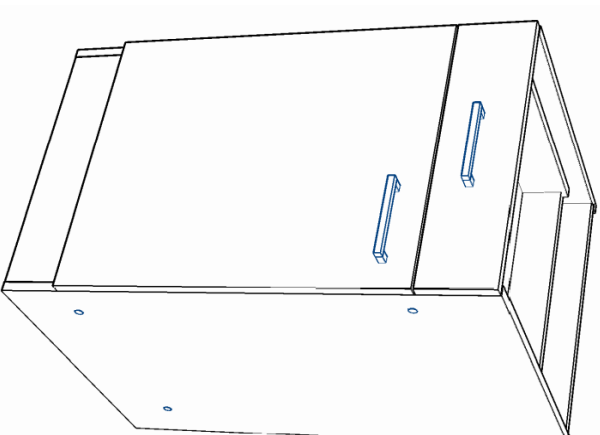
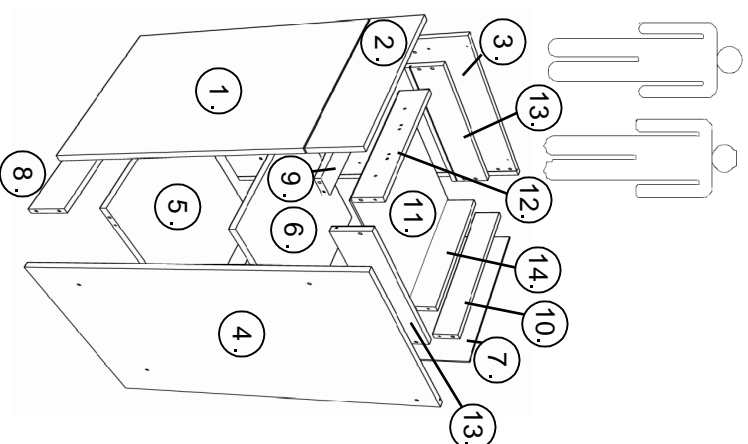
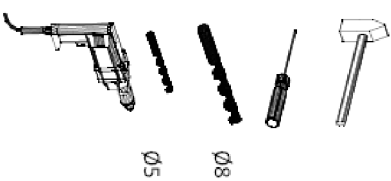

497x125x16/1x

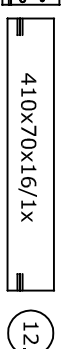
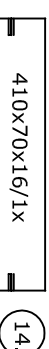
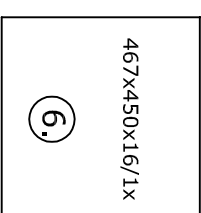
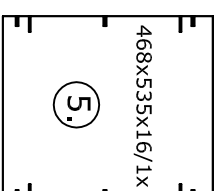
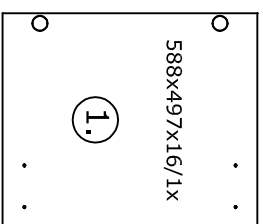

719x479x3/1x

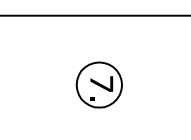
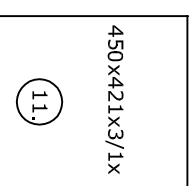
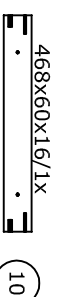
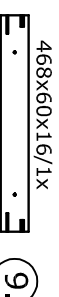

Schritt 1.

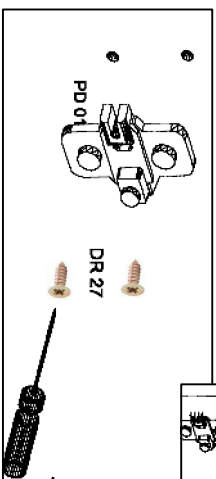
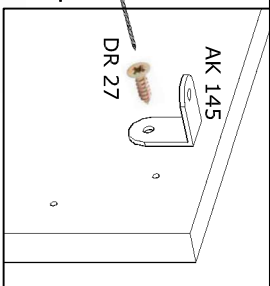
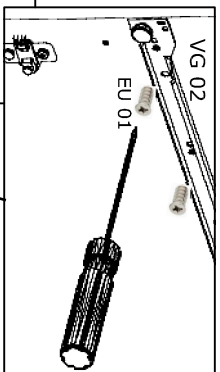

Schritt 2.

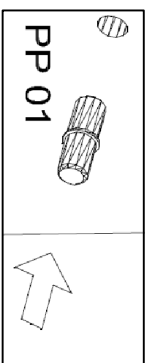
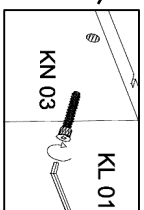

Schritt 5.

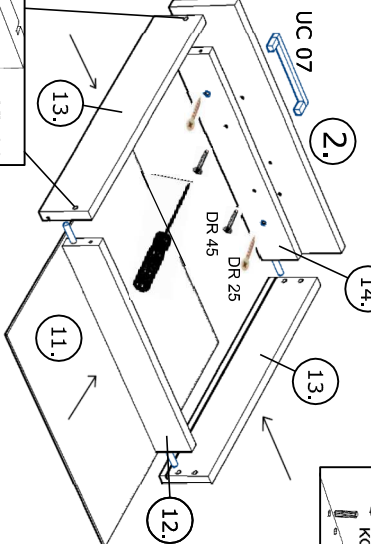
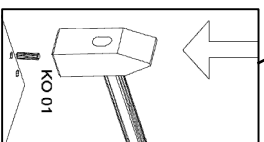

Schritt 6.

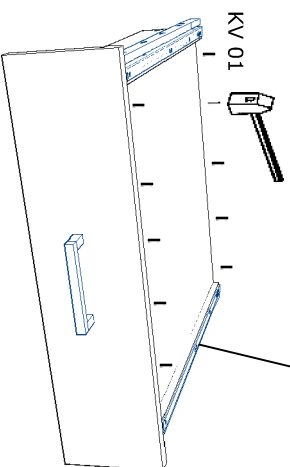
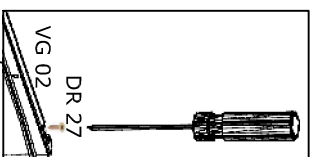

Schritt 3.

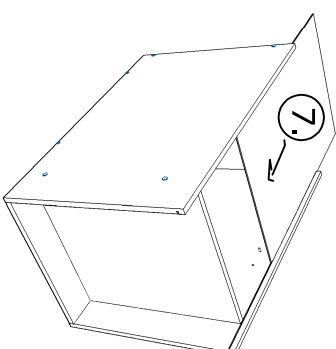



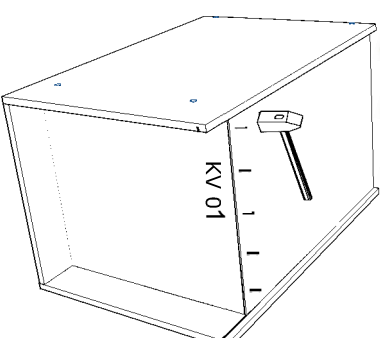



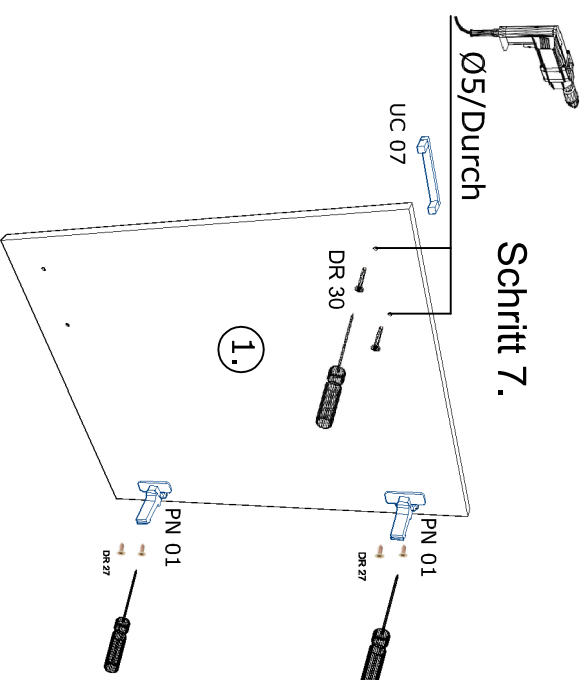







Schritt 4.



Schritt 7.



name	tip.	stk.	bild
KO 01	8x35	10	
KN 03	7x50	4	
PL 12		2	
PP 01	d=5	4	
PN 01-PD 01		2	
SP 01	4x32	2	
DR 27	3,5x16	16	
KV 01	1,5x20	5	
UC 07	96	1	
DR 30	4,0x30	2	
KL 01	4	1	
AK 121		2	
AK 145	30x30	4	
DR 25	4,0x25	4	



1 h 50 min

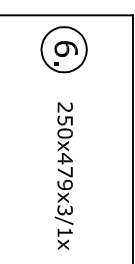
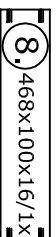
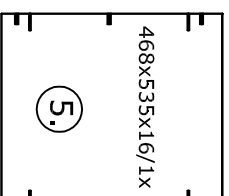
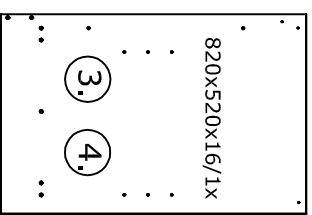
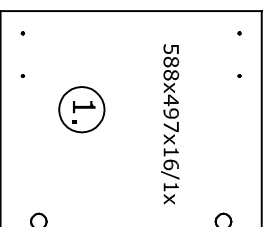
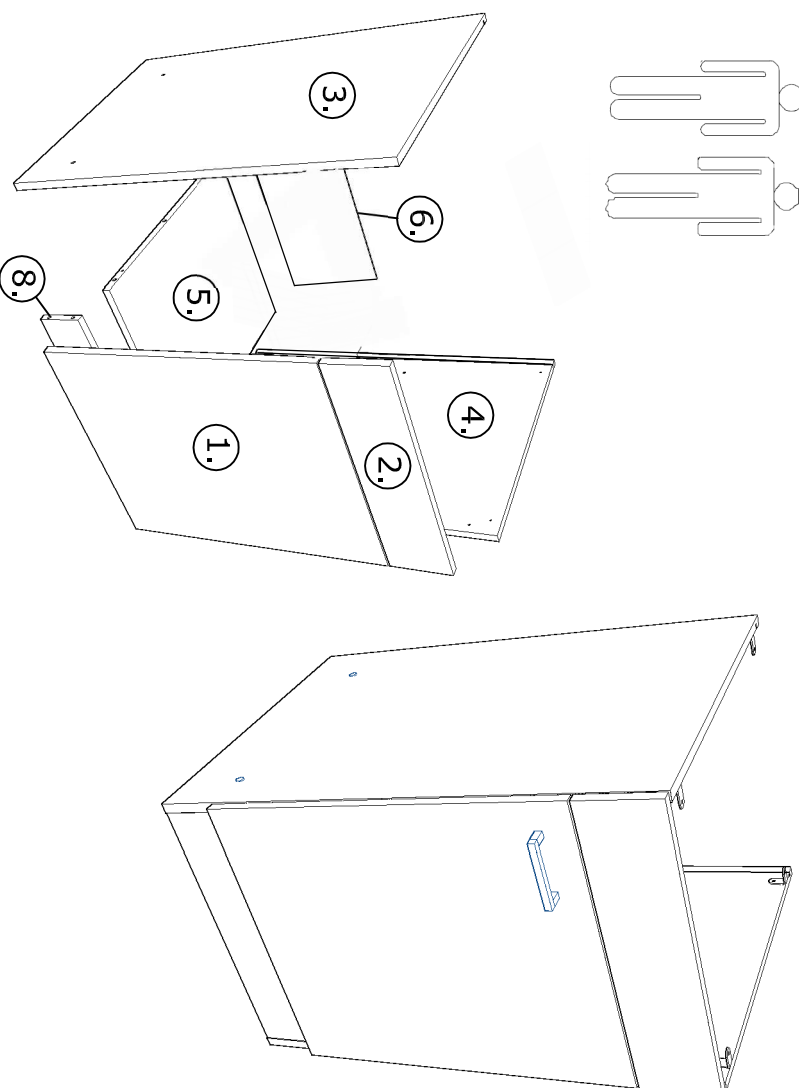
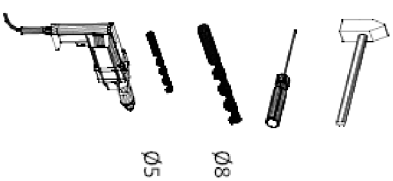
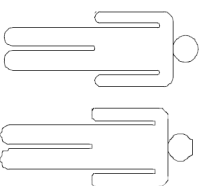

Schritt 1.

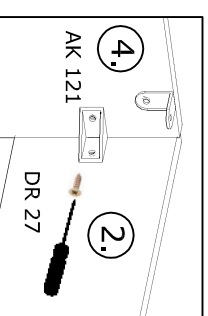
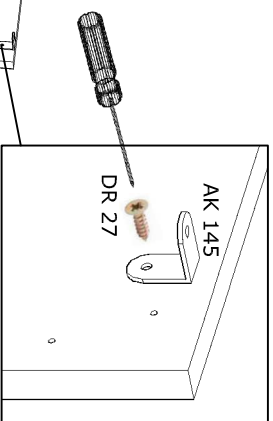
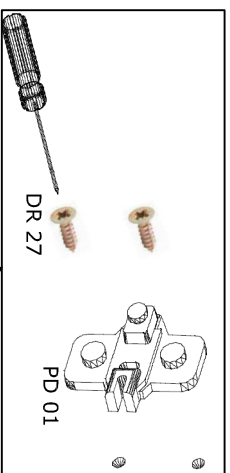

Schritt 4.

Schritt 3.

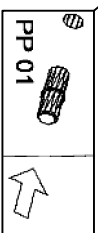
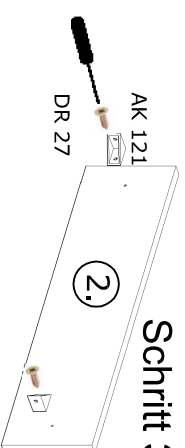

Schritt 2.

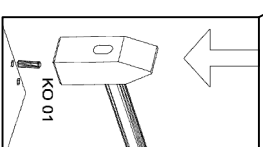
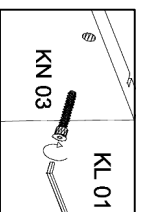

Schritt 6.

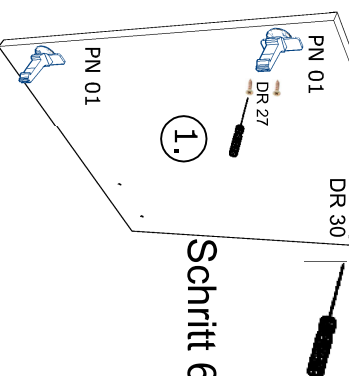

Schritt 7.

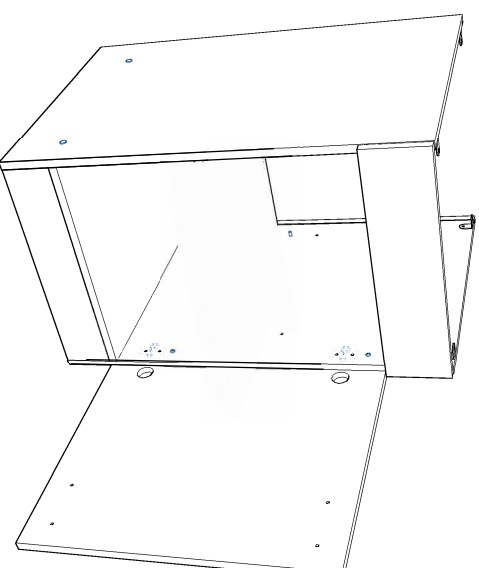

Schritt 5.

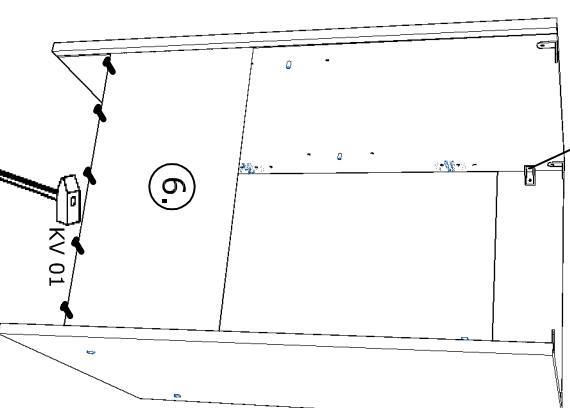

Mit Ø5 Bohrer durchbohren



SP01  
2x



8x



DR 25

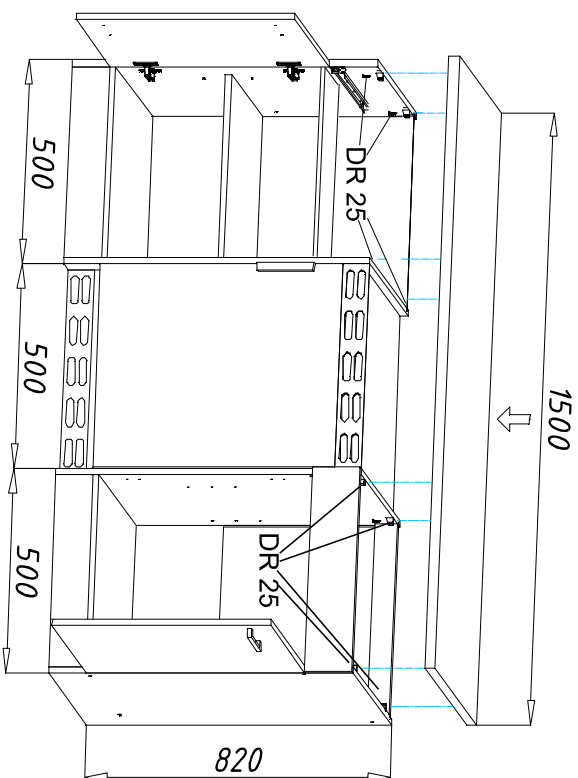
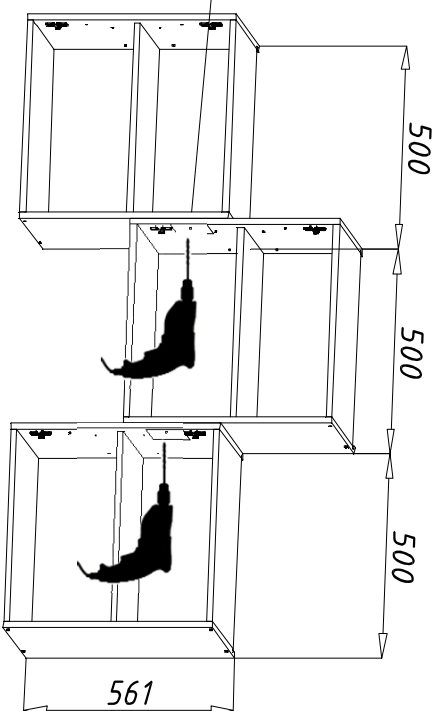
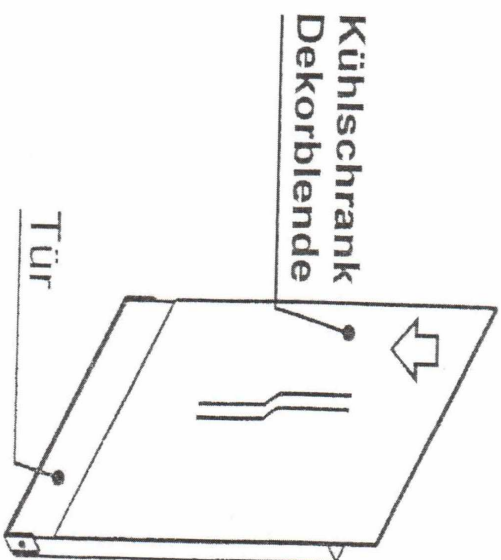
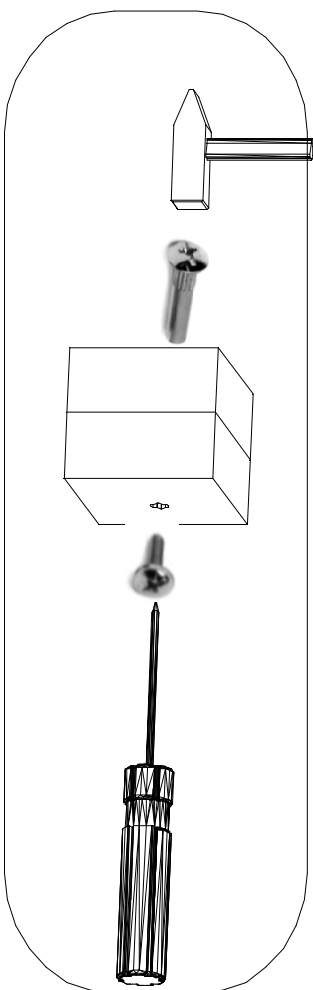



1. Modell

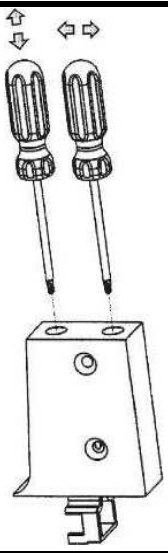

2. Modell

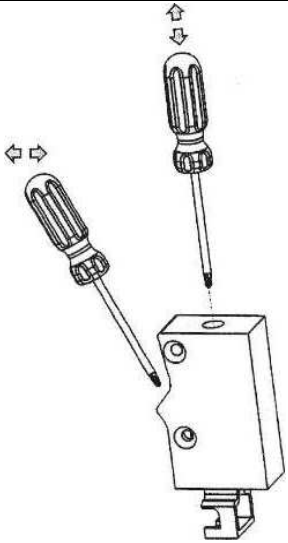

3. Modell

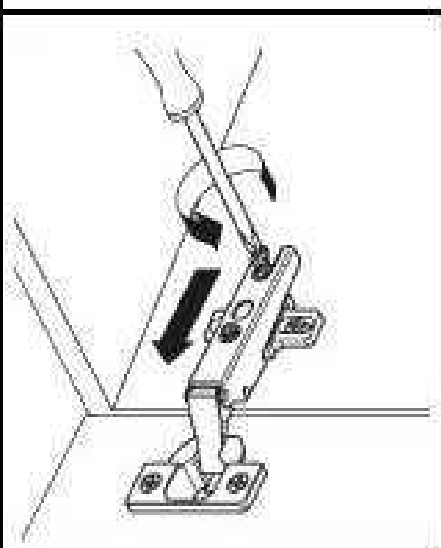
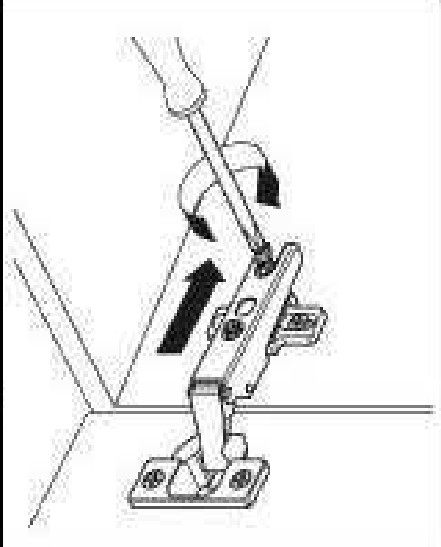
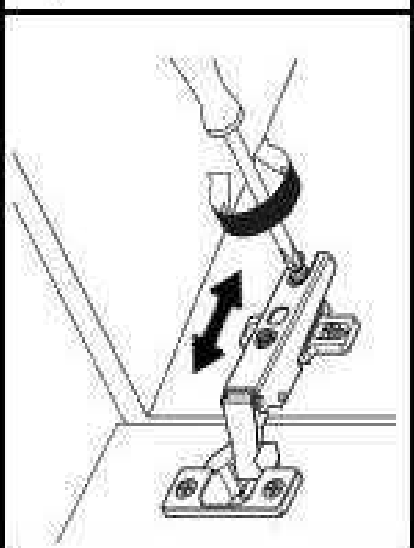
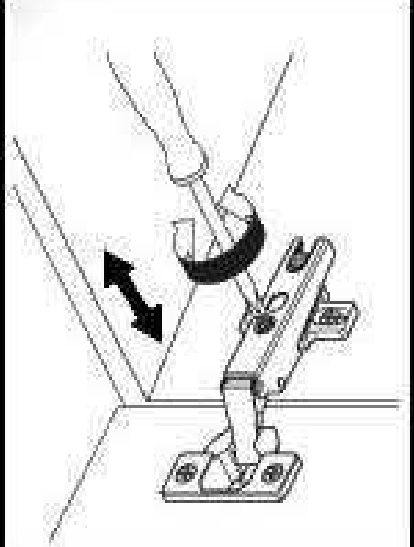
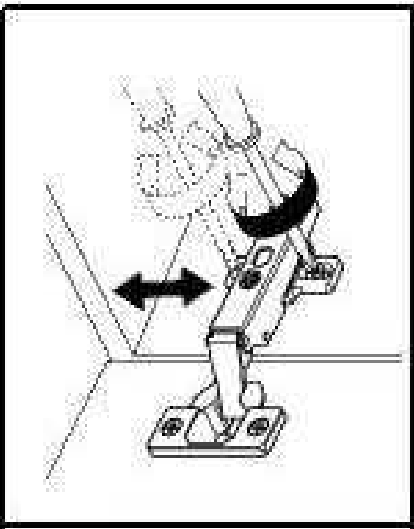
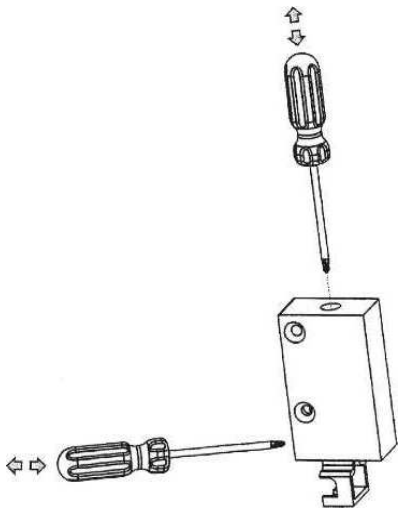

**ACHTUNG!!!  
ATTENTION!!!**

